

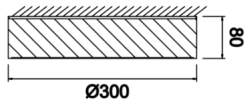

Armatür Grubu	Sıva Üstü
Montaj Tipi	Sıva Üstü
Armatür Rengi	RAL 9005 - RAL 9006 - RAL 9010
Gövde	Alüminyum Ekstrüzyon
Optik	Opal Difüzör
Işık Kaynağı	LED
Elektriksel Koruma Sınıfı	CLASS II
IP	40
IK	02
Çalışma Sıcaklığı	-20°C / +40°C
Işık Akısı	13095 lm / 16320 lm / 4370 lm / 6195 lm
Tüketim Gücü	120 W / 40 W / 51 W / 96 W
Armatür Verimliliği	124,5 lm/W
Renkssel Geri Verim (CRI)	>80
Işık Renk Sıcaklığı (CCT)	2700K/3000K/4000K/6500K
Renk Toleransı	< 3 SDCM
Driver Tipi	On/Off
Driver Markası	Tridonic
LED Markası	Samsung
Giriş Gerilimi / Frekans	220-240 V AC 50/60 Hz
Güç Faktörü	>0.9
Surge	1kV
THD (AKIM)	>%20
LED ömrü	>50.000 saat
Opsiyon	On-Off / Dali / 1-10V / Acil Durum Kiti

Teknik Çizim



Fotometrik Eğri

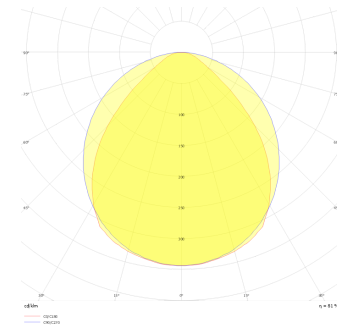

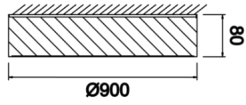
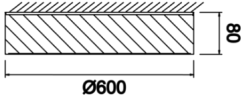
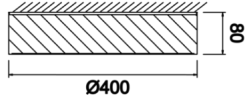
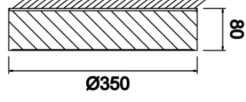

Fotometrik Eğri

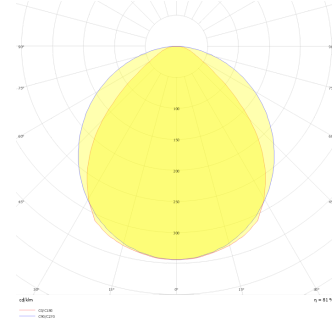

Drums



Sıva Üstü Armatür

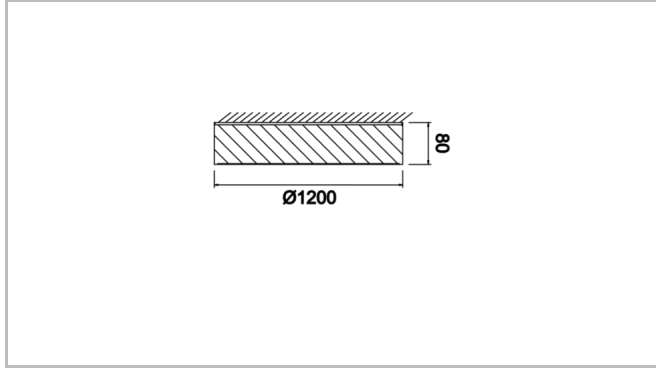

Sipariş Kodu	Ürün Kodu	Güç (W)	Işık Akısı (LM)	CRI	CCT (K)	Optik	Ölçüler (mm)
	DRM 040 008 040S 8040 10 99 OP 40 00	40	4370	>80	4000	120° Opal Difüzör	Ø50
	DRM 060 008 051S 8040 26 99 OP 40 00	51	6195	>80	4000	120° Opal Difüzör	Ø60
	DRM 090 008 96S 8040 26 99 OP 40 00	96	13095	>80	4000	120° Opal Difüzör	Ø90
	DRM 120 008 120S 8040 10 99 OP 40 00	120	16320	>80	4000	120° Opal Difüzör	Ø120