

# Dimple Drums Pendant

DDR 080 025 048P 9040 10 99 OP 40 00



Sarkit Armatür



<b>Armatür Grubu</b>	Sarkit
<b>Montaj Tipi</b>	Sarkit
<b>Armatür Rengi</b>	RAL 9005 - RAL 9006 - RAL 9010
<b>Gövde</b>	Dkp Sac
<b>Optik</b>	Opal Difüzör
<b>Işık Kaynağı</b>	LED
<b>Elektriksel Koruma Sınıfı</b>	CLASS II
<b>IP</b>	40
<b>IK</b>	02
<b>Çalışma Sıcaklığı</b>	-20°C / +40°C
<b>Işık Akısı</b>	6290
<b>Tüketim Gücü</b>	48
<b>Armatür Verimliliği</b>	108 lm/W
<b>Renkset Geri Verim (CRI)</b>	>80
<b>Işık Renk Sıcaklığı (CCT)</b>	2700K/3000K/4000K/6500K
<b>Renk Toleransı</b>	< 3 SDCM
<b>Driver Tipi</b>	On/Off
<b>Driver Markası</b>	Tridonic
<b>LED Markası</b>	Samsung
<b>Giriş Gerilimi / Frekans</b>	220-240 V AC 50/60 Hz
<b>Güç Faktörü</b>	>0.9
<b>Surge</b>	1kV
<b>THD (AKIM)</b>	>%20
<b>LED ömrü</b>	>70.000 saat
<b>Opsiyon</b>	On-Off / Dali / 1-10V / Acil Durum Kittli

Teknik Çizim

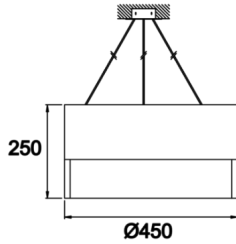
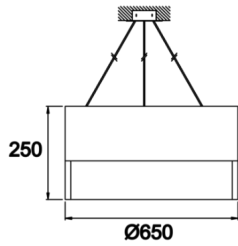

Fotometrik Eğri

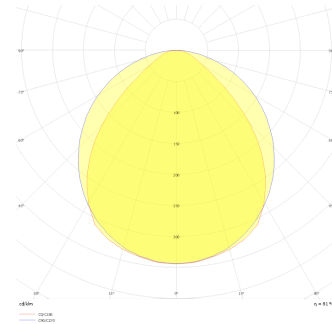

[www.atelaydinlatma.com](http://www.atelaydinlatma.com)

# Dimple Drums Pendant

DDR 080 025 048P 9040 10 99 OP 40 00



Sarkit Armatür

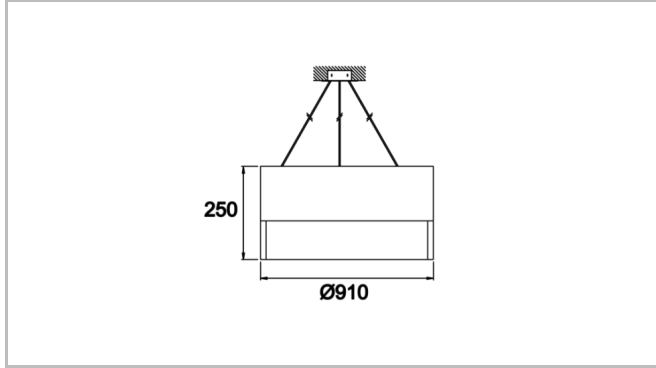

Sipariş Kodu	Ürün Kodu	Güç (W)	Işık Akısı (LM)	CRI	CCT (K)	Optik	Ölçüler (mm)
	DDR 080 025 048P 9040 10 99 OP 40 00	48	6290	>80	4000	120° Difüzör	Ø900x250